



JOC3121,JOC3122,JOC3123 Series

DIP6 2Channel DC Input Zero-Cross Photo TRIAC

Features

- Isolation voltage between input and output
Viso : 5,000Vrms
- 2Channel 6pin DIP zero-cross photocoupler, triac driver output
- High repetitive peak off-state voltage VDRM :
Min. 1200V
- High critical rate of rise of off-state voltage(dV/
dt : MIN. 1000V / μ s)
- RoHS Compliance
All materials be used in device are followed EU
RoHS directive
- MSL class1

Applications

- AC Motor Drives
- AC Motor Starters
- E.M. Contactors
- Lighting Controls
- Solenoid/Valve Controls
- Solid State Relays
- Static Power Switches
- Temperature Controls

SCHEMATIC

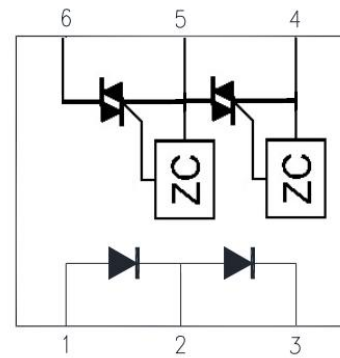

PIN DEFINITION

1.Anode1	6.MT11
2.Cathode1/ Anode2	5.MT12/MT21
3.Cathode2	4.MT22

PACKAGE OUTLINE

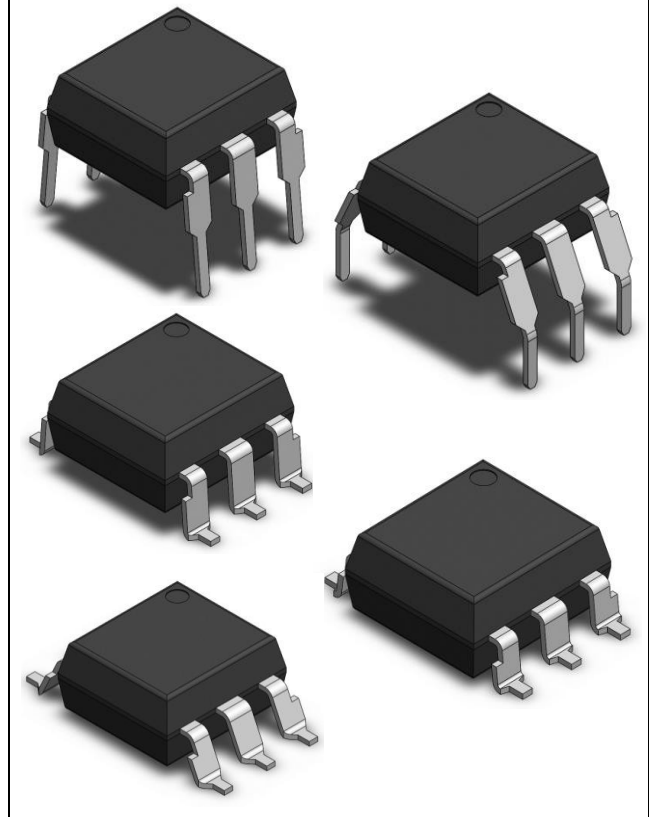

ABSOLUTE MAXIMUM RATINGS				
PARAMETER		SYMBOL	Rating	UNIT
Input	Forward Current	I _F	25	mA
	Reverse Voltage	V _R	6	V
	Junction Temperature	T _J	125	°C
	Power Dissipation	P	50	mW
Output	Off-State Output Terminal Voltage	V _{DRM}	1200	V
	On-State RMS Current	I _{D(RMS)}	100	mA
	Peak Repetitive Surge Current (PW=1ms, 120pps)	I _{TSM}	1	A
	Junction Temperature	T _J	125	°C
	Output Power Dissipation	P _o	300	mW
Total Power Dissipation		P _{tot}	330	mW
Isolation Voltage (Note 1)		V _{iso}	5000	V _{rms}
Operating Temperature		T _{opr}	-40 ~ +110	°C
Storage Temperature		T _{sig}	-55 ~ +150	°C
Soldering Temperature (Note 2)		T _{sol}	260	°C

Note: Ambient temperature = 25°C, unless otherwise specified. Stresses exceeding the absolute maximum ratings can cause permanent damage to the device. Exposure to absolute maximum ratings for long periods of time can adversely affect reliability.

Note 1: AC For 1 Minute, R.H. = 40 ~ 60%

Isolation voltage shall be measured using the following method.

- (1) This device is considered as a two-terminal device: Pins 1,2 and 3 are shorted together, and pins 4,5 and 6 are shorted together
- (2) The isolation voltage tester with zero-cross circuit shall be used.
- (3) The waveform of applied voltage shall be a sine wave.

Note 2: For 10 Seconds

RECOMMENDED OPERATION CONDITIONS

CHARACTERISTICS		SYMBOL	MIN.	Typ.	MAX.	UNIT
Supply Voltage		V_{AC}	-	-	240	Vac
Forward Current	JOC3121	I_F	20	22.5	25	mA
	JOC3122		15	20	25	mA
	JOC3123		7.5	10	25	mA
Operating Temperature		T_{opr}	-40	-	110	°C

Note: Recommended operating conditions are given as a design guideline to obtain expected performance of the device. Additionally, each item is an independent guideline respectively. In developing designs using this product, please confirm specified characteristics shown in this document.

ELECTRICAL OPTICAL CHARACTERISTICS							
PARAMETER	SYMBOL	MIN.	TYP.	MAX.	UNIT	TEST CONDITION	
INPUT CHARACTERISTICS							
Forward Voltage	V_F	-	2.0	2.4	V	$I_F = 10 \text{ mA}$	
Reverse Current	I_R	-	0.05	10	μA	$V_R = 5\text{V}$	
OUTPUT CHARACTERISTICS							
Peak Blocking Current, Either Direction ^{Note2}	I_{DRM}	-	-	500	nA	$V_{DRM} = 600\text{V}$	
Peak On-State Voltage, Either Direction	V_{TM}	-	1.8	3.0	V	$I_{TM} = 100 \text{ mA Peak}$	
Critical rate of Rise of Off-State Voltage ^{Note3}	dv/dt	1000	-	-	$\text{V}/\mu\text{s}$	$V_{in} = 240\text{Vrms}$	
COUPLE CHARACTERISTICS							
Led Trigger Current, Current Required to Latch Output, Either Direction	JOC3121	I_{FT}	-	-	15	mA	Main Terminal Voltage = 3V
	JOC3122		-	-	10	mA	
	JOC3123		-	-	5	mA	
Holding Current, Either Direction	I_H	-	200	-	μA		
ZERO CROSSING CHARACTERISTICS							
Inhibit Voltage	V_{INH}	-	10	20	Volts	$I_F = \text{Rated } I_{FT}$, MT1-MT2 Voltage above which device will not trigger.	
Leakage in Inhibited State	I_{DRM2}	-	-	500	μA	$I_F = \text{Rated } I_{FT}$, Rated V_{DRM} , Off State	

1. All test conditions apply to Each channel products.(Channel 1:Pin 1-2&5-6、 Channel 2:Pin 2-3&4-5)
2. Test voltage must be applied within dv/dt rating.
3. This is static dv/dt . Commutating dv/dt is a function of the load-driving thyristor(s) only.

PACKAGE DIMENSIONS (Dimensions in mm unless otherwise stated)

Through hole package Lead Forming

DIP type Dimension

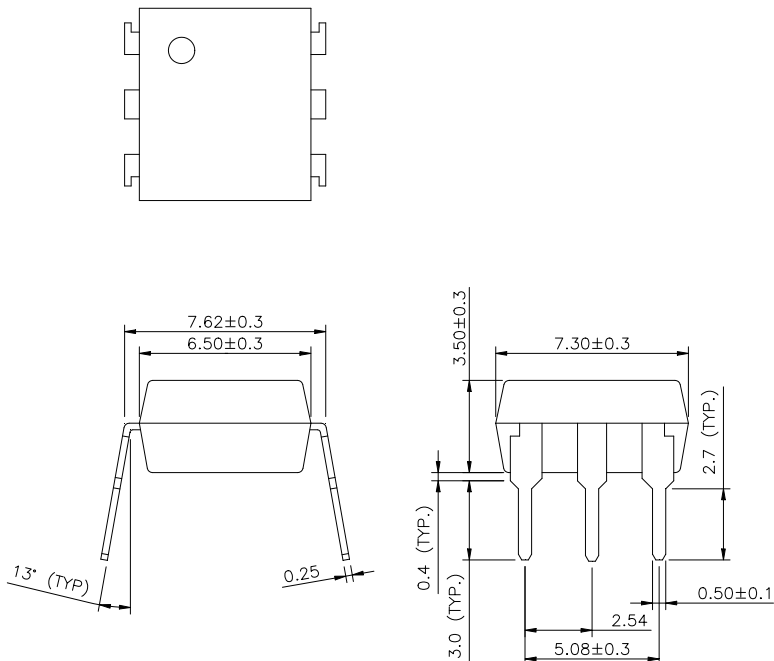

M type Dimension

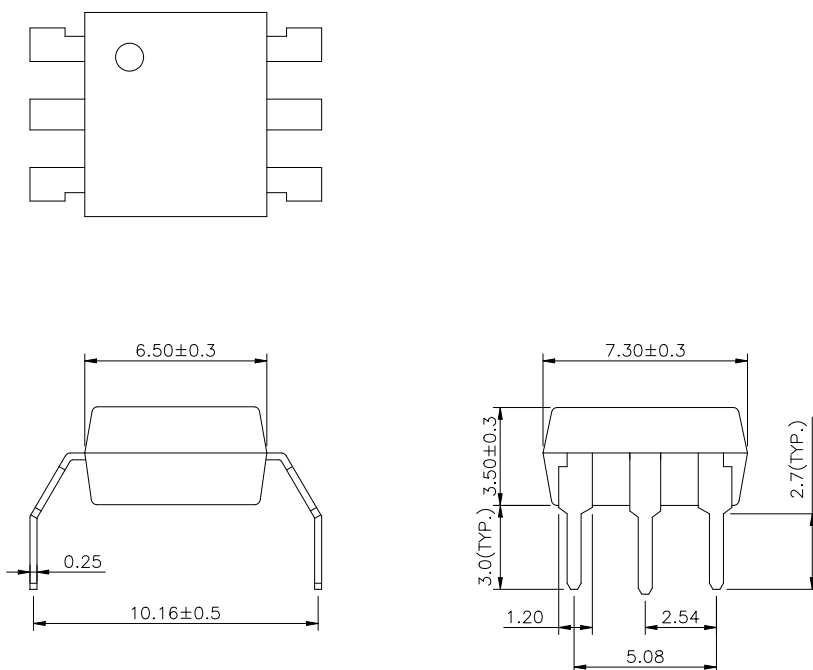

PACKAGE DIMENSIONS (Dimensions in mm unless otherwise stated)

Surface Mount Lead Forming

S type Dimension

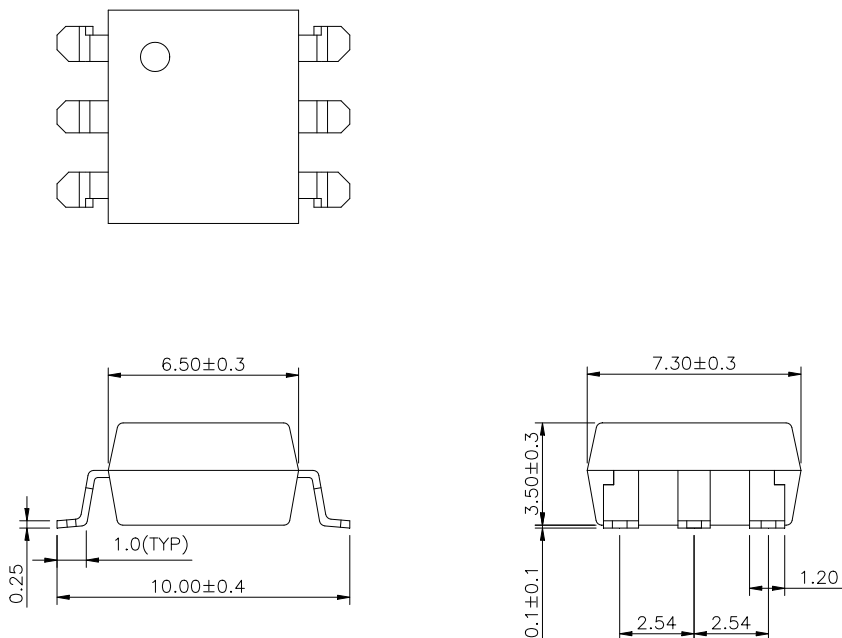

SM type Dimension

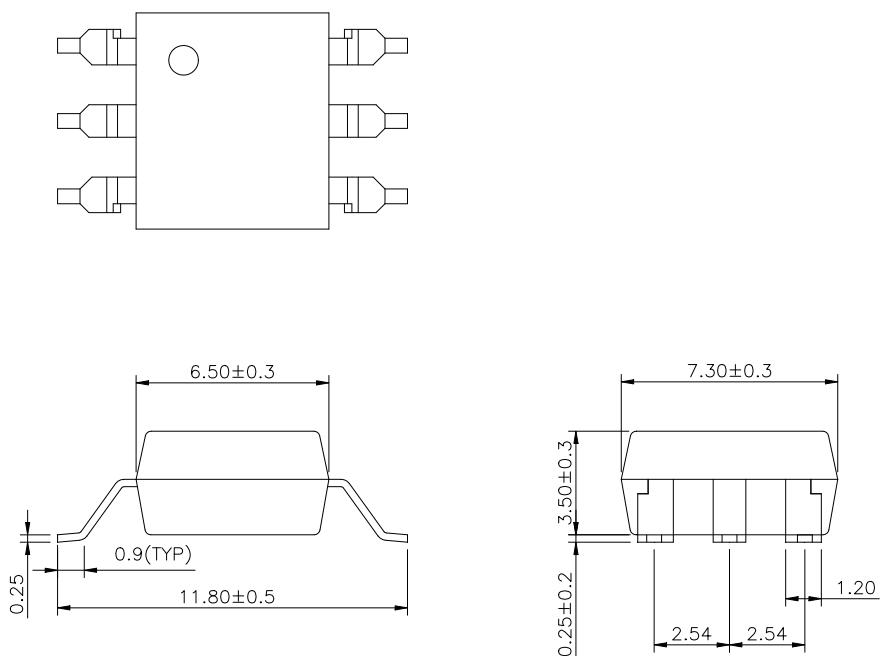

TAPING DIMENSIONS (Dimensions in mm unless otherwise stated)

S type Taping Dimensions

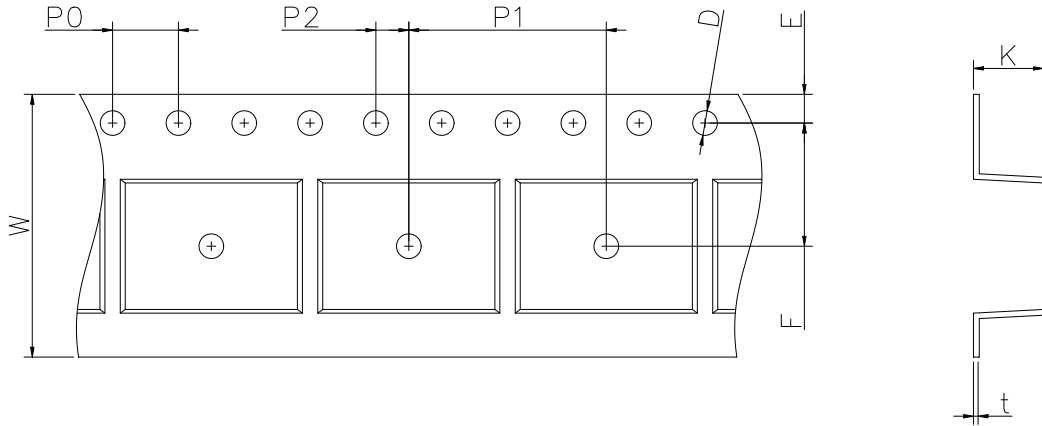

Dimension Symbol	D	E	F	P0	P1	P2	t	W	K
Dimension (mm)	1.55±0.2	1.75±0.2	7.5±0.2	4.0±0.2	12.0±0.2	2.0±0.2	0.35±0.2	16.0±0.3	4.25±0.2

Tape & Reel Packing Specifications

Option T1

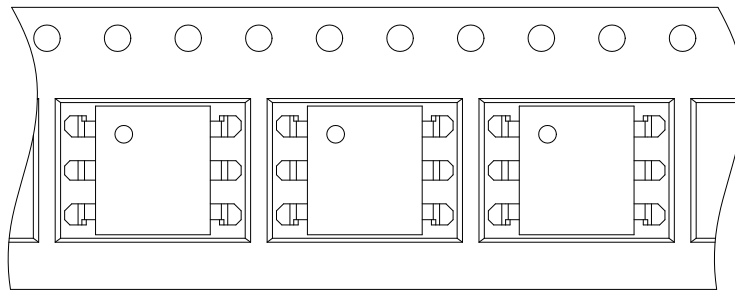

Option T2

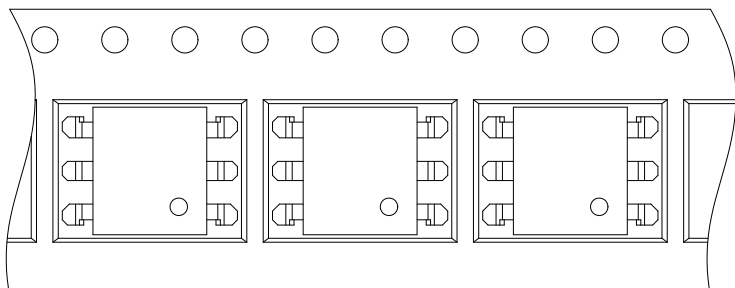

TAPING DIMENSIONS (Dimensions in mm unless otherwise stated)

SM type Taping Dimensions

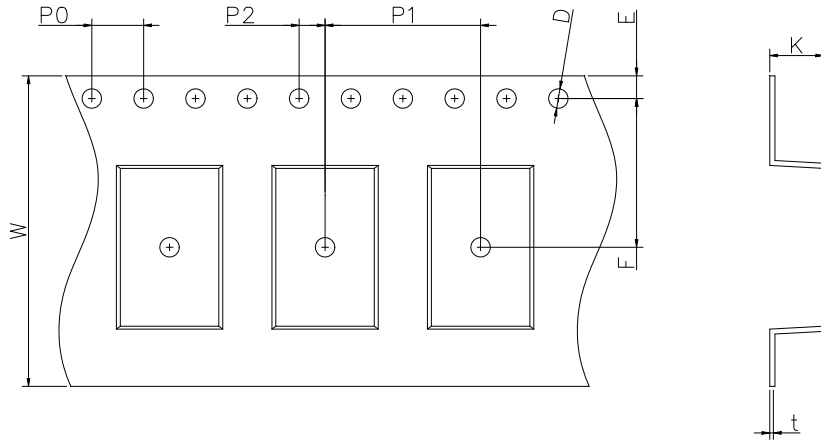

Dimension Symbol	D	E	F	P0	P1	P2	t	W	K
Dimension (mm)	1.5±0.2	1.75±0.2	11.5±0.2	4.0±0.2	12.0±0.2	2.0±0.2	0.4±0.2	24.0±0.3	4.15±0.2

Tape & Reel Packing Specifications

Option T1

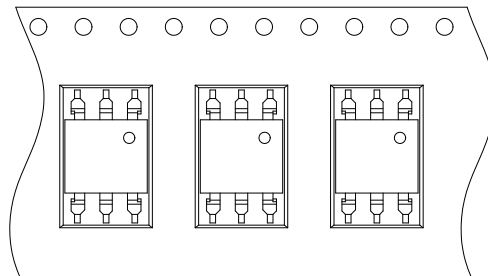

Option T2

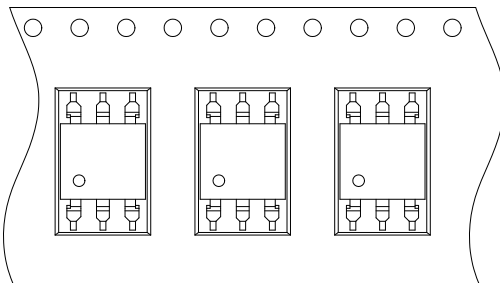

MARKING INFORMATION

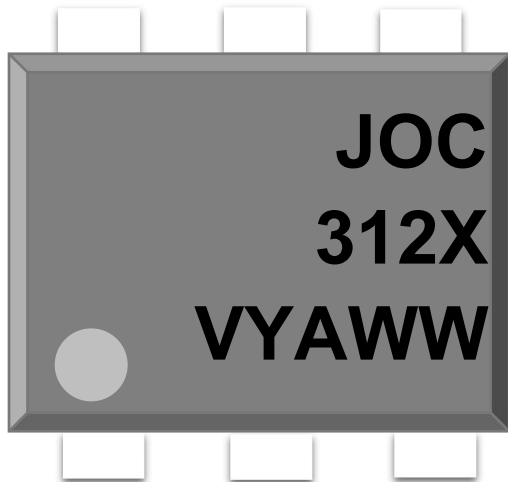

JOC : Company Abbr.
312X : Part Number & Rank
V : VDE Option
Y : Fiscal Year
A : Manufacturing Code
WW : Work Week

ORDERING INFORMATION

JOC312X(Y)(Z)-GV

JOC – Company Abbr.
312X – Part Number (3121/3122/3123)
Y – Lead Form Option (M/S/SL/None)
Z – Tape and Reel Option (T1/T2)
G –Green Option (G or None)
V – VDE Option (V or None)

LABEL INFORMATION



Precautions for Soldering

IR Reflow soldering

One time soldering reflow is recommended within the condition of temperature and time profile shown below. Do not solder more than three times.

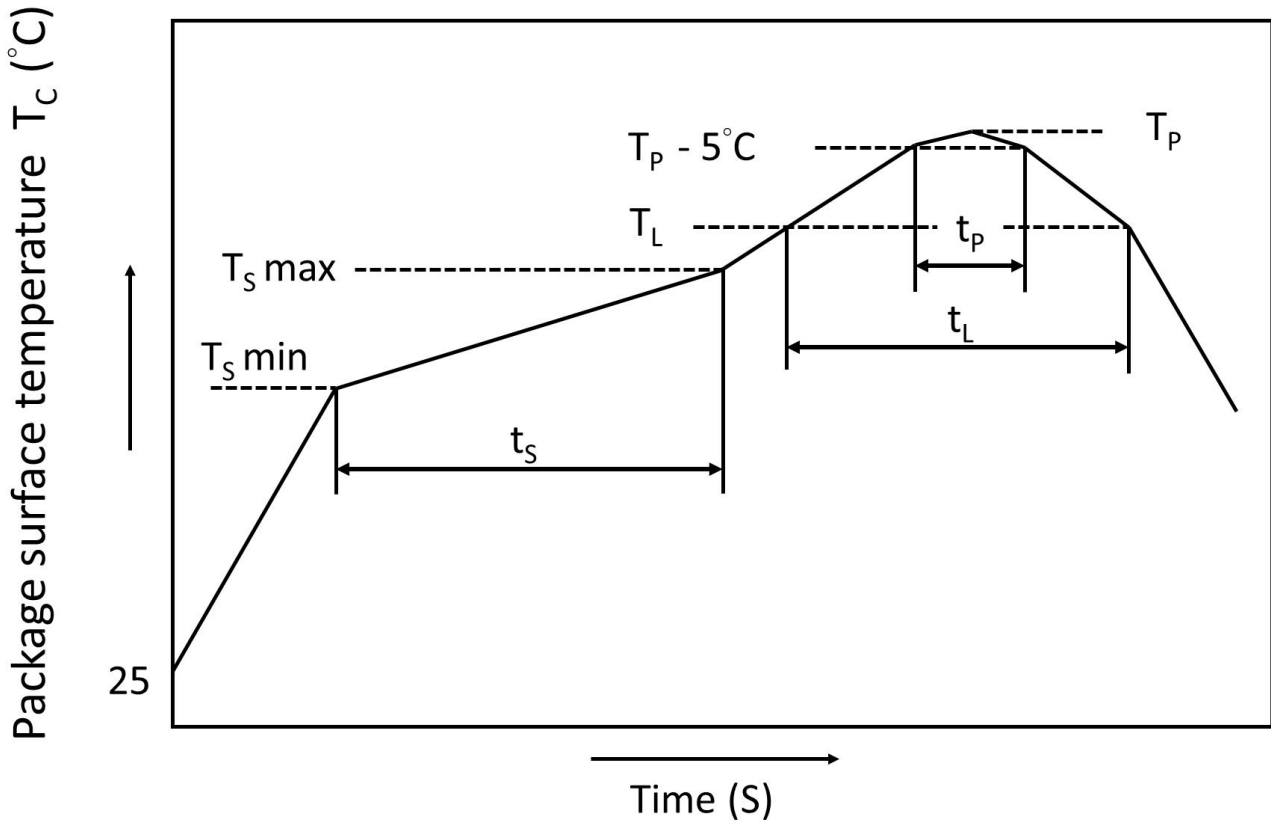

	Symbol	Min	Max	Unit
Preheat temperature	T_s	150	200	°C
Preheat time	t_s	60	120	s
Ramp-up rate (T_L to T_P)			3	°C/s
Liquidus temperature	T_L	217		°C
Time above T_L	t_L	60	100	s
Peak Temperature	T_P		260	°C
Time during which T_c is between ($T_P - 5$) and T_P	t_p		20	s
Ramp-down rate			6	°C/s

DISCLAIMER

- Our company is continually improving the quality, reliability, function and design. Our company reserves the right to make changes without further notices.
- The characteristic curves shown in this datasheet are representing typical performance which are not guaranteed.
- Our company makes no warranty, representation or guarantee regarding the suitability of the products for any particular purpose or the continuing production of any product. To the maximum extent permitted by applicable law, Our company disclaims (a) any and all liability arising out of the application or use of any product, (b) any and all liability, including without limitation special, consequential or incidental damages, and (c) any and all implied warranties, including warranties of fitness for particular.
- The products shown in this publication are designed for the general use in electronic applications such as office automation, equipment, communications devices, audio/visual equipment, electrical application and instrumentation purpose, non-infringement and merchantability.
- This product is not intended to be used for military, aircraft, medical, life sustaining or lifesaving applications or any other application which can result in human injury or death.
- Please contact Our company sales agent for special application request.
- Immerge unit's body in solder paste is not recommended.
- Parameters provided in datasheets may vary in different applications and performance may vary over time. All operating parameters, including typical parameters, must be validated in each customer application by the customer's technical experts. Product specifications do not expand or otherwise modify Our company's terms and conditions of purchase, including but not limited to the warranty expressed therein.
- Discoloration might be occurred on the package surface after soldering, reflow or long-time use. It neither impacts the performance nor reliability.